



SPINEL 3G

MOBILE SURGICAL FLUOROSCOPIC
X-RAY SYSTEM

The Power of Passion

GEMSS

Superior Image Performance

The rapidly changing Surgical Imaging market demands increased functionality and improved clinical applications, and the SPINEL 3G high performance surgical C-arm delivers in every detail, from its highly-attractive, modern appearance to its advanced engineering. Additional sub-handles and a minimized footprint; intuitive pictographic UI; superior image quality [from the smallest detail to L-spine lateral projection]; and lower dose; these are just a few of the advances of the SPINEL 3G.

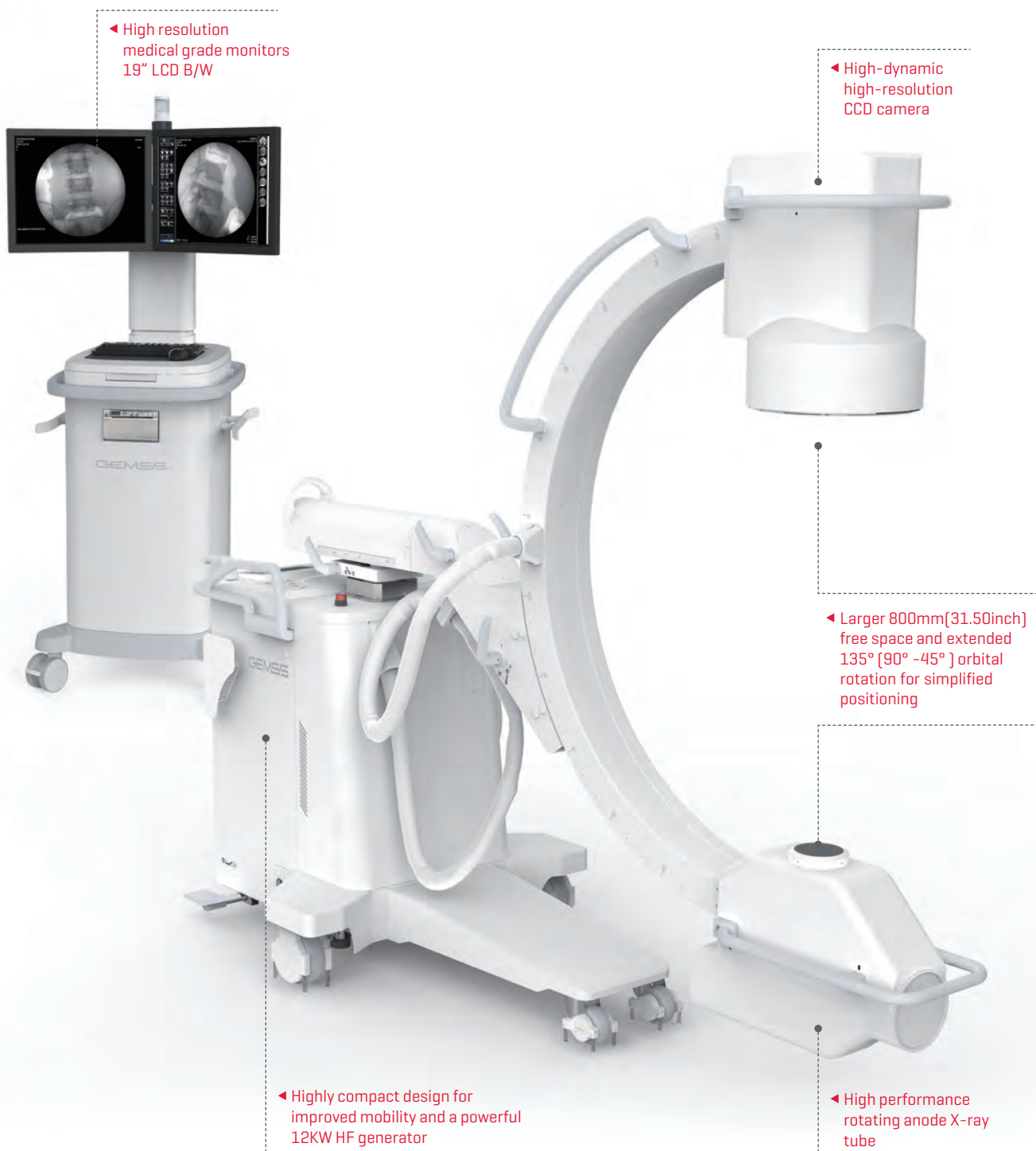

Optimized Workflow

- Intuitive pictographic UI and Touchscreen OP panel
- Additional sub-handles for enhanced mobility
- Compact design provides more free space for operation
- Motorized cart elevation for easier monitor viewing
- Extended time and multi-frame recording capability
- Multi-speed [1,2,4,8,15,25 frames/sec]

* Thermal printer

* indicates optional item



Intuitive Touchscreen Menu

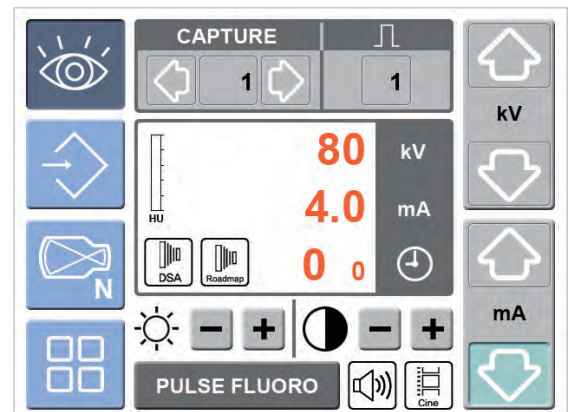

Op UI

Specifications at a Glance



12kw, High Frequency Generator



1K x1K High Resolution CCD Camera



135° Wide Orbital Rotation With Large SID Distance



Touchscreen C-arm Control



High Performance Rotating Anode X-ray Tube



Display of AKR and Cumulative Air Kerma [mGy/min. and mGy]



Lowering Dosage
-Virtual collimator
-Pulse mode



High Resolution B/W 19" LCD Medical Grade Monitors
-1,000cd/m²



Stability
-H.U.Display



Convenience
-Single power input
-Sub-handles
-Automatic monitor up/down
-3rd monitor
-Foot switch



Easy Archiving And Documentation
-DICOM 3.0
-CD/DVD Burner
-DICOM Paper print support
-USB Port

Smart CX-View



Database Management

- More convenient search & save capabilities
- Manage patient information
- Before & after surgery comparison



Unlimited Image Memory

- Unlimited patient capacity
- Unlimited study images



Versatile Diagnostic Tools

- Zoom, contrast, reverse, invert
- Filtering, edge enhancement
- Annotation



PACS Connectivity With DICOM 3.0

- Store and print, modality worklist management
- MPPS, storage commitment, and Import & export

High-quality Imaging

Wide exposure range(0.2~10mA)

Improved penetration of dense anatomy with Boost Mode [up to 20mA]

Pulse technology supports 30 FPS [frames / sec] for more precise operation

Smart ABC [Auto Brightness Control]

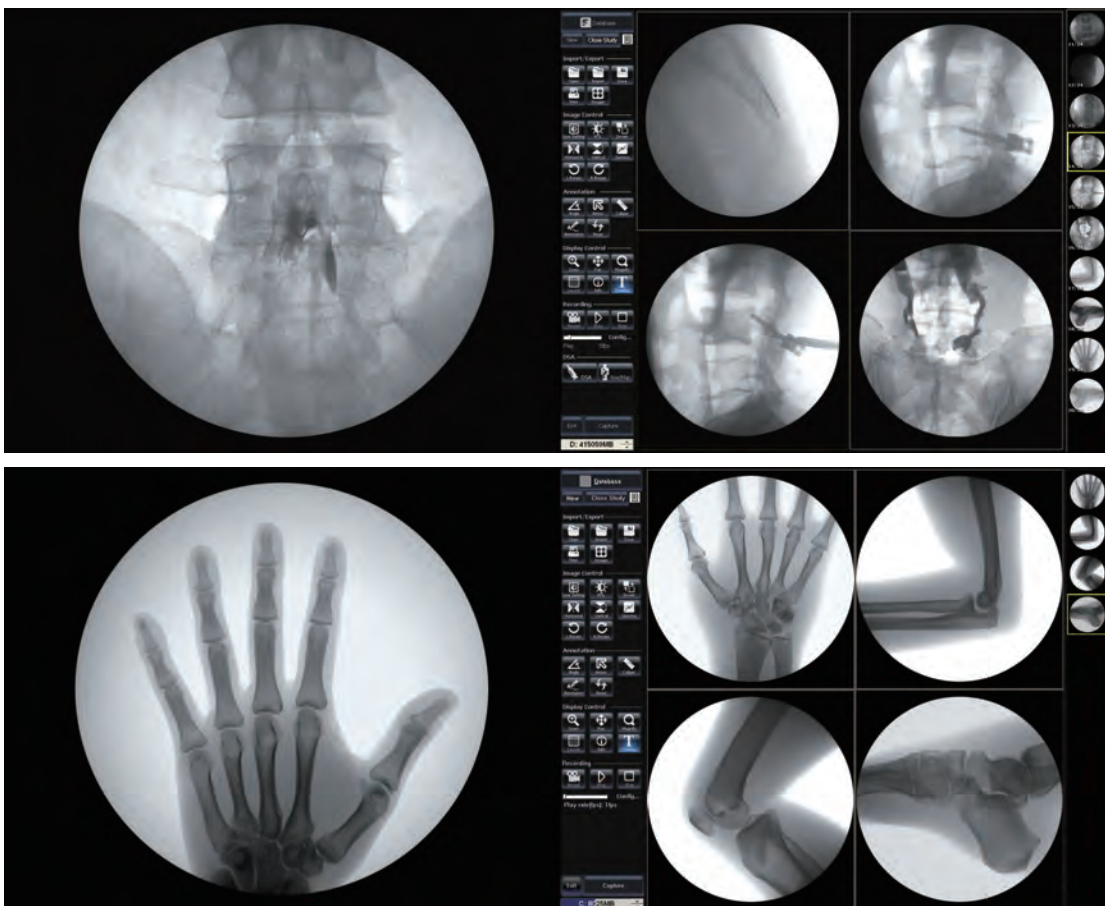

Applications

- General Surgery
- Orthopedic Surgery
- Neurology
- Urology
- Pain Management

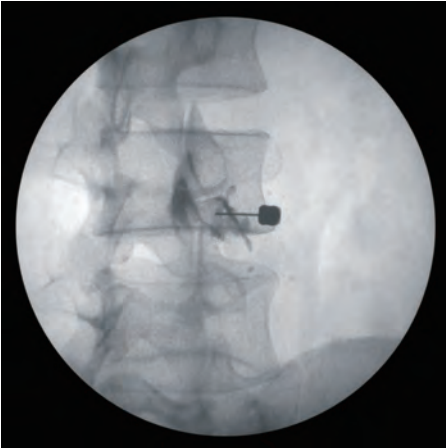

Pain Management

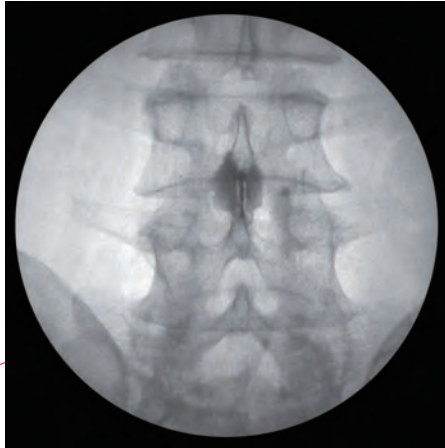

Pain Management



Spine



Spine



Orthopedics

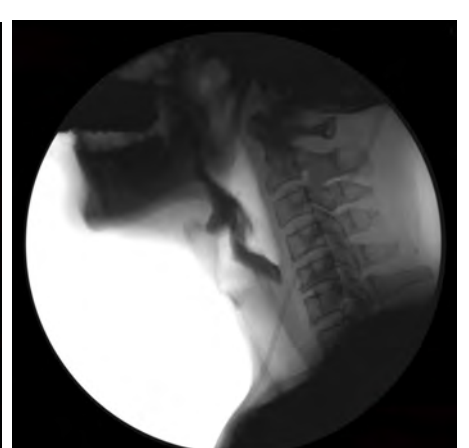

Esophagography of rehabilitation



Thoracic Verte

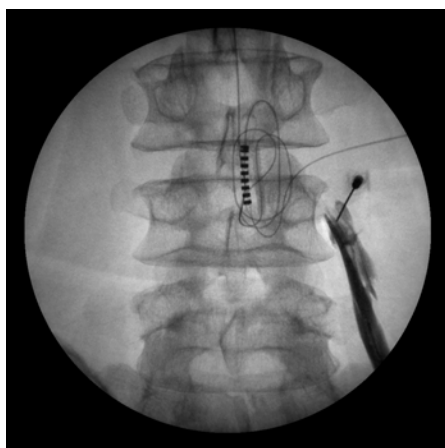

L-spine pain management



Cervical Block

Flexible Movement

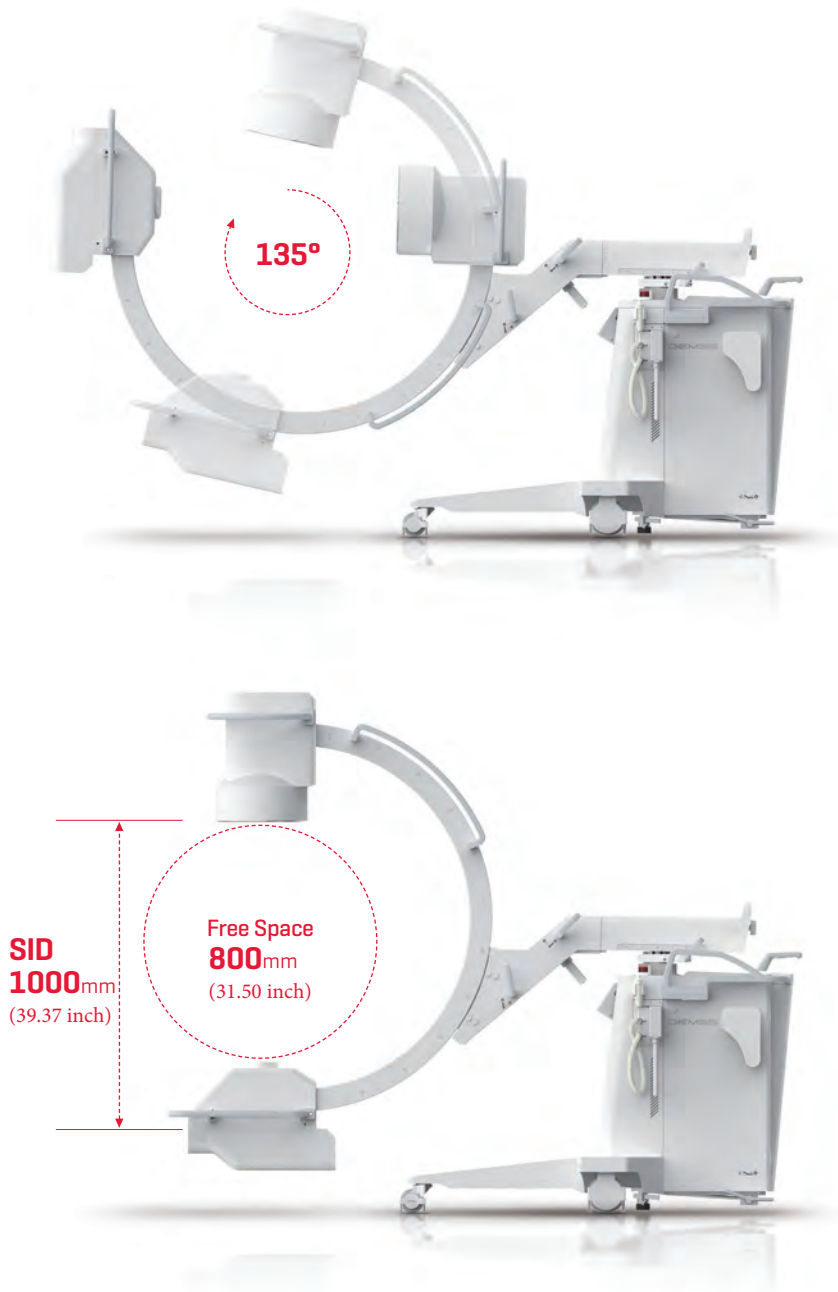

GEMSS

GEMSS NORTHAMERICA INC.

www.gemss-northamerica.com

SPINEL3G-NA-1507

©GEMSS MEDICAL SYSTEMS reserves the right to make any changes in design and specifications contained herein without prior notice and will not be liable for any consequences resulting from the use of this publication. Any technical data contained in this document may vary within defined tolerances. Original images always lose a certain amount of data when reproduced. Please contact your local GEMSS sales representative for the most current information.